

Universal Transmitters for Smart Digital HiQDT Sensors



Measurements

- pH
- ORP
- Dissolved Oxygen (D.O.)
- Ion Selective (ISE)
- Conductivity (EC)

Features

- Automatic recognition of HiQDT sensors
- Isolated, Reversible & Scalable 4-20mA
- **Security for IIoT Smart Field Installations**
- Seamless plug & play hot-swap of sensors
- **Sensor remote capabilities include:**
 - Calibrate & Modify Configuration
 - View all smart analytics such as serial number, time in use & current calibrations
- **Transmitter remote capabilities include:**
 - Scale & Configure 4-20mA output
 - Modify MODBUS master & slave nodes

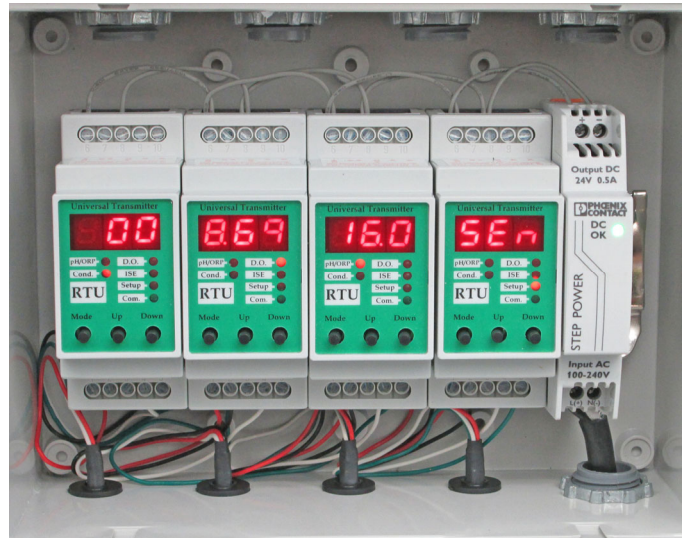

- Type of connected sensor is indicated with illuminated LED in main display mode. If node of sensor is not known the automated search node feature will find it. Once the node address is found the sensor type is automatically determined.
- Additional parameters beyond main process value can be shown using the 'Up' and 'Down' keys as detailed in this documentation. Output is configured in setup LED mode.
- **All major functionality from physical interface can also be achieved remotely via MODBUS RTU calls**

3TX-RTU-D UNIVERSAL SMART 4-20mA TRANSMITTER for HiQDT MODBUS RTU pH, ORP, Dissolved Oxygen (D.O.), Ion Selective (ISE) & Conductivity (EC) Smart Digital Sensors

- Provides local display & isolated, scalable & reversible 0-20mA or 4-20mA output
- **Simultaneously functions as MODBUS RTU master to smart HiQDT MODBUS RTU sensor and MODBUS RTU slave to upstream PLC. ALL sensor registers can be made accessible from MODBUS RTU slave port. Security parameter allows for field adjustable access control levels on MODBUS RTU slave port anywhere from read only for sensor and transmitter, to write only for transmitter or allowing full read & write access for both sensor & transmitter. Page 5 provides further details.**
- **Automatic translation between transmitter & sensor node addresses (see page 6)**
- Display current mA output based upon current sensor reading & scaling setup
- **Galvanic isolation between sensor input, power & analog output (3000V rating)**
- **Universal software automatically detects measurement type of mating sensor & loads all necessary associated parameters without any user action required**
- Temperature & Absolute mV can be display for pH/ORP/ISE/DO sensors. Temperature & raw conductivity can be displayed for conductivity sensors.
- Customized user-defined default settings can be programmed without charge
- Provides isolated 9VDC power & RS-485 serial port for smart HiQDT sensors
- Smart HiQDT MODBUS RTU sensors store calibration & analytic info in non-volatile EEPROM memory for seamless plug and play hot-swap in field
- **Sensors calibrations are performed by handheld communicator (HHC), Windows software or Touchscreen Controller through MODBUS slave port.**
- **Notifies when connected sensor needs recalibration (user adjustable threshold)**
- Supported Data Ranges for Mating Smart digital HiQDT MODBUS RTU Sensors:
 - **pH:** -2.000 to +16.000 (*actual range is always limited by sensor specs*)
 - **ORP:** ±1000.0mV Standard Style or ±2000.0mV Wide Range Style
 - **Dissolved Oxygen (D.O.):** 0.00-150.00 ppm | 0.0-1,500.0 % Saturation
 - **Ion Selective (ISE):** 0.01-9.99 / 10.0-99.9 / 100-999 for ppm ranges & 1.00-9.99 / 10.0-99.9 / 100-99 kilo-ppm ranges (ppm equivalent is X 1000)
 - **Conductivity (EC):** 0.01-9.99/10.0-99.9/100-999 for µS/cm ranges and 1.00-9.99 / 10.0-99.9 / 100-999 for mS/cm ranges. The computed units salinity (PSU), TDS & resistivity (MΩ) supported for display & output
 - **Temperature:** -40.0 to +210.0 °C for all sensor types (display values only)

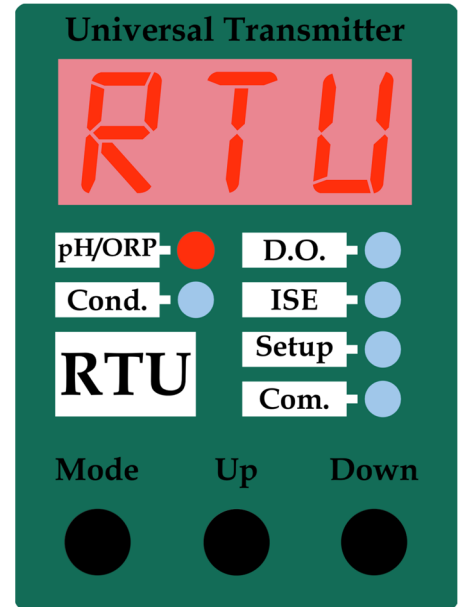

Programming

3TX-RTU has 3 digit display & 6 LEDs to setup & display values. 'Mode' is used to navigate. Programming done by 3 keys. 'Mode' toggles & 'Up' or 'Down' used to scroll & select. Setup Parameters entered via 'Mode'. Values changed using 'Up' or 'Down'. The 3TX-RTU automatically selects & illuminates LED based upon the type of sensor which is connected. **If softwarelock (P01) "On" no changes can be made. Set P01 to "Off" to allow for changes to scaling & configuration. If keys are not used for several minutes then software lock resets back "On".**

MAIN FEATURES

SMART UNIVERSAL TRANSMITTER:

The 3TX-RTU-D supports all of the common liquid analytical electrochemical measurements parameter of pH, ORP, dissolved oxygen (D.O.), ion selective (ISE) and conductivity. Scanning feature finds node address of sensor. Universal transmitter automatically loads appropriate parameters for sensor type found at node address obtained from scan.

COMPLEMENTARY 3TX MODULES FOR 3TX-RTU:

3TX-REL: Alarm & Relay controller with simple supervision, On/Off or Time Proportional Control (TPC) Modes
3TX-TOT: Computes pH compensated "Total ISE" from Free ISE & pH analog inputs, 0/4-20mA analog & MODbus output

SMART DIGITAL MODBUS RTU SENSOR INPUT

3TX-RTU-D interfaces smart digital HiQDT MODBUS RTU sensors for low-noise operation. **Cable lengths up to 1,000 meters (3,280 feet) can be supported in field. All sensors terminated with NEMA 6P rated waterproof snap connector.**

HIGHLY CONFIGURABLE ANALOG OUTPUT

3TX-RTU provides scalable, proportional reversible 4-20mA or 0-20mA analog current loop output for any mating connected sensor input. **Minimum scaling down to 2% of the full range input of sensor allowing for a very high resolution signal to be sent to the mating analog input device.** Analog output is galvanically isolated from input with 3KV rated optocoupler.

TECHNICAL SPECIFICATIONS

Mechanical

Housing:	Lexan UL94V-0 (Upper part) Noryl UL94V-0 (Lower part)
Mounting:	M36 for 35 mm DIN rail
IP Class:	Housing IP40. Connector IP20
Connector:	Max 16A. Max 2.5 mm ² Max torque 0,6 Nm
Temp.:	Usage -15 to +50 °C (Storage -35 to +75 °C)
Weight:	75 grams (2.64 ounces)
Dimensions:	D 58 x W 36 x H 86 mm (2.3" X 1.4" X 3.4")
CE mark:	EN61326A 

Electrical

Power Supply:	24VDC ±10%
Power	60mA max when pH/ORP/ISE/DO
Consumption:	80mA max when conductivity (EC)
Input Ranges:	See pages 6 to 16 for details
Sensor Input:	Smart Digital HiQDT MODBUS RTU
Temp Sensor:	Integral Platinum TC Element
Temp Range:	-40 to +210°C ± 0.3°C
Temperature	Automatic Temperature
Compensation:	Compensation (ATC) is Standard
Analog Output:	0-20mA or 4-20mA, max. 500Ω
Output Hold:	Automatic if sensor is not connected

BENEFITS OF USING MATING SMART DIGITAL HiQDT RS-485 MODBUS RTU SENSORS

- **Integral RS-485 MODBUS RTU interfaces all-modern PLC controllers & data acquisition systems.**
- **Communicator provides easy management of field installations** without the cost of a mating transmitter. This is ideal for locations where a local display is not necessary or possible due to installation limitations.
- **Intelligent management of sensor calibrations and service life-cycle** for efficient commissioning & maintenance. All aspects of installation are completely portable from the shop to the field site location.
- **Days in use** value is stamped for calibrations that are performed. This allows for predictive scheduling of maintenance in the PLC to ensure the accurate measurement in the field based upon user defined criteria.
- **All digital sensors ensure** reliable operation even in noisy process environments unlike analog sensors.
- **No degradation in digital communications** with very long cable runs. **Max 1,000 meters (3,280 feet) for pH, ORP, ISE & DO sensors & Max 610 meters (2,000 feet) for conductivity sensors with 3TX-RTU-D.**
- Bridging connections & modifying installations easily without loss of signal quality with **NEMA 6P & IP67 rated quick disconnect waterproof and corrosion-resistant dual snap connector.** Simple plug and play operation for intelligent maintenance planning & smart management of sensor installations and stocking.
- **Low-cost snap digital extension cables** facilitate consolidation of very many HiQDT sensors outputs into one panel enclosure where very many remote field installations can all be conveniently all viewed at once.
- **Intelligent HiQDT handheld communicator software identifies type of sensor connected & autoloads** correct features. There exists no possibility of accidentally using the wrong set of options or settings.
- **All Extension cables for HiQDT sensors are inter-compatible.** Uniform extension cables minimize stocking. Separate field installation guide details available options to commission & exchange sensors.

SMART MODBUS RTU SENSORS FOR USE WITH 3TX-RTU UNIVERSAL TRANSMITTER

- **Entire line of proven Iotron™ inline, immersion, submersible, twist lock, sanitary, HOT-TAP retractable pH & ORP sensors** made by ASTI are **ALL available** for use with 3TX-RTU universal smart transmitter
- The very rugged low-profile **impact & break resistant parabolic pH glass element** optimized for use in **slurries & high viscosity applications** (X3XX series) is **ONLY** available for the smart digital type sensors
- The novel **extreme dehydration resistant** style reference technology that allows for **prolonged exposure to dry conditions** and **intermittent wet & dry use** is **ONLY** available for the smart digital type sensors
- **Entire line of proven Iotron™ inline, immersion, submersible, twist lock, sanitary, HOT-TAP retractable ion selective (ISE) sensors** made by ASTI are **ALL available** in the smart digital HiQDT type configuration
- **Rugged Industrial AST-DO-UNIVERSAL Galvanic Dissolved Oxygen Sensors** for inline, immersion, submersible, twist lock, sanitary, HOT-TAP retractable installations are available in HiQDT configuration
- **Entire line of proven industrial inline, immersion, submersible, twist lock, sanitary, HOT-TAP retractable 2-electrode contacting conductivity** are **ALL available** in the smart digital HiQDT type configuration
- **Waterproofing Option "A", "B", "C", "G", "H" or "IT" is recommended for any HiQDT smart digital sensor** with integral RS-485 MODBUS RTU digital output for immersion or fully submersible installations.

Field Commissioning of Transmitter Wiring Schematic

The 3TX-RTU universal smart transmitter is typically supplied preconfigured with female snap to tinned leads tinned leads panel mount connector installed onto a suitable field ready enclosure assembly. The HiQ4M male snap connector of the smart digital MODBUS RTU sensor is interfaced with female snap connector on 3TX-RTU universal smart transmitter assembly. HiQDT MODBUS RTU sensors are precalibrated ready for immediate plug & play field use.

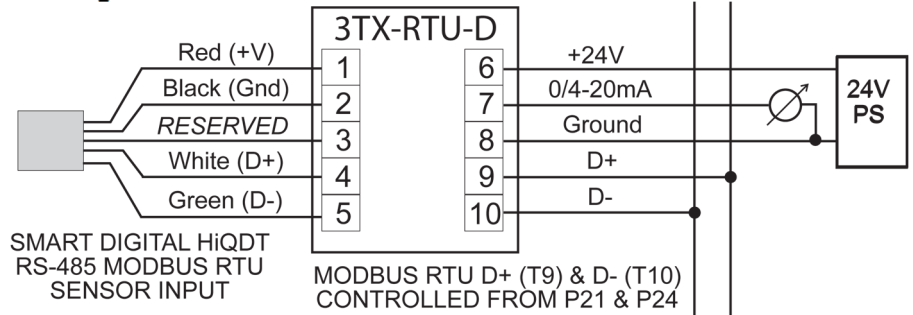

If softwarelock (Setup parameter P01) is "On" all of parameters can only be read. Set P01 Software Lock to "Off" to change values. The P01 software lock will automatically reset back to "On" if no key is pressed for several minutes.

User Setup Parameters

No	Parameter	Description	Range	Default
P01	Lock	Software Lock	On / Off	On
P02	Address	Address on MODbus	Off, 1...247	Per Order
P03	Baudrate	MODbus baudrate	9,600 / 19,200	Per Order
P04	Analog Output Type	Toggle for Current Loop Type	4-20mA, 0-20mA	Per Order
P05	Analog Output Mode	Select Polarity of Analog Output	noninverted, inverted	Per Order
P06	0/4 mA Whole	Scale Low setpoint for output - Whole Percent	0% to 98%	Per Order
P07	0/4 mA Dec.	Scale Low setpoint for output - Decimal Point 0-97.XX	XX.00% - XX.99%	Per Order
P08	20 mA Set	Scale High setpoint for output - Whole Percent	2% to 100%	Per Order
P09	20 mA Set	Scale High setpoint for output - Decimal Point 2-99.XX	XX.00% - XX.99%	Per Order
P10	D.O. Units Selected	Select between ppm and % Saturation units for output	ppm or % Sat	Per Order
P11	Conductivity Units Selected for Output	If Conductivity Sensor Type = 6 (Standard/High) then choices are uS/cm, Salinity (PSU) or TDS If Conductivity Sensor Type = 7 (Ultralow) then choices are uS/cm, MΩ Standard or MΩ for UPW	For Sensor Type = 6 uS/cm, PSU, TDS or For Sensor Type = 7 uS/cm, MΩ, UPW	Per Order
P12	Conductivity Sensor Cell Constant (K)	Indicates nominal cell constant for connected sensor From K=0.01/cm to K=20.00/cm	0.01 to 20.0	Per EC Sensor
P13	Conductivity Sensor Range Mode	Indicates the range mode scaling factor for EC sensor "UL"=2, "Std"=200, "Hi"=2,000	2..2,000	Per EC Sensor
P14	0/4mA Offset	Trim Low	±9.99% *	Per Factory Cal
P15	20mA Gain (Span)	Trim High	±9.99% *	Per Factory Cal
P16	Sampling Rate	Set sampling frequency in seconds	0.5, 1.0, 2.0 and 4.0	Per Order
P17	Recalibrate Notify	Set max time since cal last performed before notification	1 to 999 Days	Per Order
P18	Display Sensor Type	1=pH, 2=ORP, 3=Wide ORP, 4=DO, 5=ISE, 6=Cond Standard/High Style, 7=Cond Ultralow Style	1..7	Per Sensor
P19	Formula Weight	Formula Weight of Measured Ion - Only for ISE sensors	6.94..655.35	Per ISE Sensor
P20	Type of TDS Units	Type of TDS units which are sent from EC Sensor	0=NaCl, 1=442, 2=KCl	Per EC Sensor
P21	Slave Node Address	Node Address of Upstream RTU Master Device	Off, 1...247	Per Order
P22	Slave Baudrate	MODbus baudrate of Upstream RTU Master Device	9,600 / 19,200	Per Order
P23	Output Hold	Current State of Analog Output Hold Feature	Off, On	Off
P24	Write Lock	Write Permissions for Upstream RTU Master Device	Off, RTU, All	Per Order
P25	Back to Default	Reset to Default	Def=Reset, Par=NoReset	Par
P26	Parity of Slave Node	Even, None	Even, None	Even

* Negative values will be shown as flashing. Shaded portions of chart above indicate display only parameters.

Par. no. 2 set node address of sensor. If no sensor is found at the current node setting then 'SEN' will flash on screen. Press any button to enter P02 node select mode. Use 'Up' & 'Down' keys to select between 'Set' to manually define node address or 'SCn' for automatic node scanning feature (use 'Mode' to enter 'SEt' or 'SCn' feature). When node is found during scan the sensor type & node address are toggled. Accept the node address & sensor type found with 'Mode' key or press 'Up' or 'Down' to continue search

Par. no. 3 sets baudrate to be used. Choices are 9,600 or 19,200.
Par. no. 4 select whether output type is 0-20mA or 4-20mA.
Par. no. 5 select whether output is inverted or non-inverted type.

Par. no. 6, 7, 8 & 9 define 0/4mA and 20mA setpoints. Appendix provides percentages corresponding with specific engineered units for various sensor. Min scaling between low/high setpoints 2% full range. Excel worksheet to compute % setpoints available.

Par. no. 10 selects ppm or % saturations units to be used as basis for output & main LED display for connected D.O. sensor.
Par. no. 11 selects measured conductivity or else computed PSU, TDS or MΩ units as basis for analog output & main LED display.
Par. no. 12 & 13 displays cell constant & range mode of EC sensor.
Par. no. 14 & 15 Trim offset for 4mA and Trim span for 20mA
Par. no. 16 define sampling rate for connected sensor in seconds
Par. no. 17 Number of days after which recalibration notification is displayed. If limit is exceeded then 'CAL' 'OLD' is displayed.
Par. no. 18 Display the sensor type which is connected

Par. no. 19 Display the formula weight of the measured ion for ISE Sensor. For anion selective sensor value is shown as flashing
Par. no. 20 Display type of TDS units which are sent by EC sensor
Par. no. 21 Set node address of MODBUS RTU slave serial port
Par. no. 22 Set baudrate of MODBUS RTU slave serial port
Par. no. 23 Set status of analog output hold feature
Par. no. 24 Security feature for slave port. If "Off" no writing is permitted at all. If "RTU" then writing allowed to transmitter. If "All" then writing is allowed to **BOTH** sensor & transmitter.
Par. no. 25 Resets **ALL** parameters back to factory set defaults

ILLUSTRATION OF VARIOUS CONFIGURATIONS FOR P24 SECURITY FEATURE

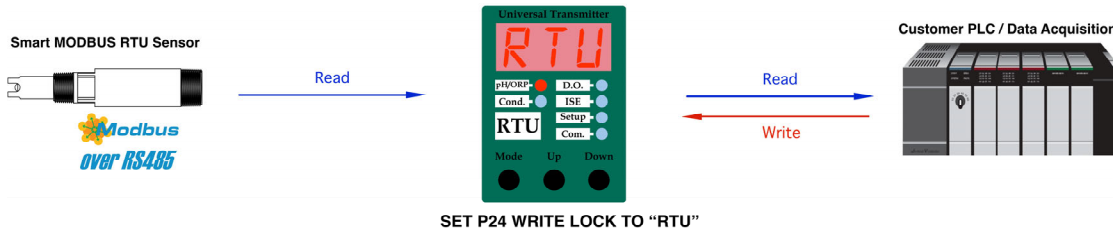
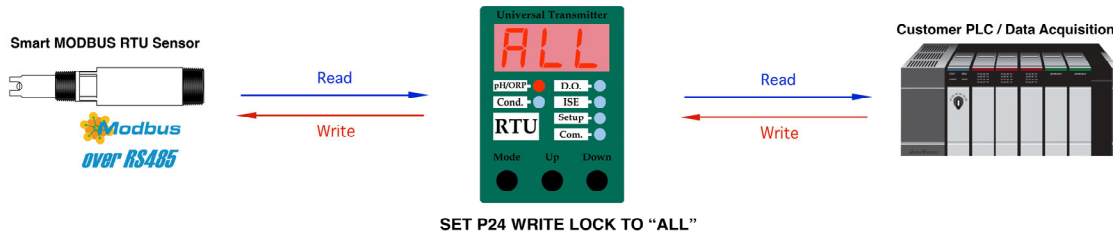

SPECIAL MODBUS SLAVE REGISTERS AVAILABLE ONLY ON 3TX-RTU-D

Access to 3TX-RTU-D modbus registers gained through MODBUS function code (03) READ HOLDING REGISTERS. Nine (9) values are available when requesting process values. Each of these registers corresponds to a user parameter on the 3TX-RTU-D transmitter. If parameter P24 is set to "RTU" or "All" then it is also possible to write to these registers as well as read through MODBUS function code (16) preset multiple registers. Values sent in succession from starting index.

Name	Range	Engineered Values	Register	Parameter
Analog Output Hold Feature	0,1	0="Off", 1="On"	40401	P23
Analog Output Set for 0-20mA or 4-20mA	0,1	0=0-20mA, 1=4-20mA	40402	P04
Toggle non-inverted or inverted output	0,1	0= non.inv, 1=inverted	40403	P05
Low 0/4mA Setpoint for Analog Output	0..9,800	0.00% to 98.00%	40404	P06/P07
High 20mA Setpoint for Analog Output	200..10,000	2.00% to 100.00%	40405	P08/P09
Units selected for D.O. sensors for output	ppm or % Sat	0=ppm, 1=% Sat	40406	P10
Units set for Std/Hi EC sensors output	EC, PSU, TDS	0=EC, 1=PSU, 2=TDS	40407	P11
Units set for Ultralow EC sensors output	EC, MΩ, MΩ UPW	0=EC, 1= MΩ, 2= MΩ UPW	40407	P11
Modbus Slave Node Address	1..247	1..247	40408	P21
Modbus Master Node Address	1..247	1..247	40409	P02

Note: Registers 40401 to 40409 correspond to Index 400 to 408

ILLUSTRATION OF P02 MASTER NODE ADDRESS & P21 SLAVE NODE ADDRESS CONFIGURATIONS WHEN INTERFACED WITH TOUCHSCREEN CONTROLLER

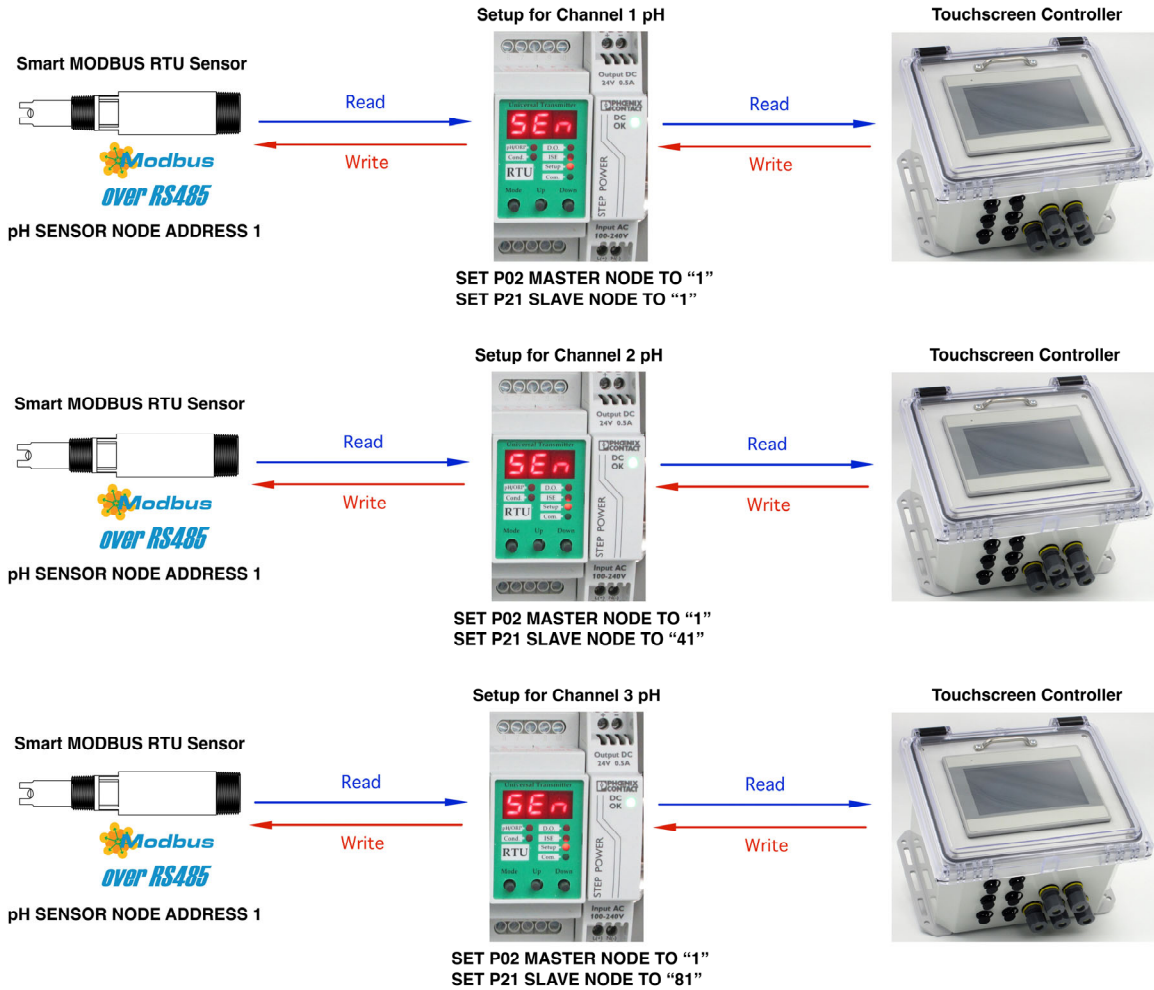

Example shown above is for use with touchscreen controller where channels 1, 2 & 3 are configured for pH. This scheme allows for seamless hot-swap plug and play operation without having to change the node address on the smart pH sensor no matter the channel. The 3TX-RTU-D P21 slave node address defines the channel to the touchscreen controller to which it is connected (see table below). For other sensor types the P02 and P21 node address assignments would differ, but the concepts would be the same as shown above.

Node Address Scheme when using with Touchscreen HiQDT PLC Controller

When 3TX-RTU-D transmitter is used with Touchscreen HiQDT PLC Controller node address MUST be set as defined in the table below. If 3TX-RTU-D transmitter & controller are ordered together node addresses can be preset at factory.

Channel #	1	2	3	4	5	6
pH sensor	1	41	81	121	161	201
Standard ORP sensor	2	42	82	122	162	202
Wide Range ORP Sensor	3	43	83	123	163	203
Dissolved Oxygen Sensor	4	44	84	124	164	204
Ion Selective (ISE) Sensor	5	45	85	125	165	205
Conductivity (EC) Sensor	6	46	86	126	166	206

COMMISSIONING AND SETUP:

ONLY the HiQDT Windows software or Handheld Communicator (HHC) can change the node address of the HiQDT smart digital RS-485 MODBUS RTU sensors (see respective manuals for details).



IMPLEMENTATION APPROACH #1 - OBTAIN PROCESS VALUES ONLY (1)

Access to **READ** core process values is gained through MODBUS function code (04) READ INPUT REGISTERS. Eight (8) values are available when requesting process values. Values can be called starting at any index and any number of values can be requested so long as it does not exceed the total number available from the starting index of the call. Values are sent in succession from the starting index of the call. If only one value is requested, then just the starting index is sent.

#	Name	Range	Engineered Values	Register	Index
1	Measurement pH	0..18,000	-2.000 to +16.000	30001	0
1	Measurement Standard Range ORP (mV)	0..20,000	-1,000.0 to +1,000.0	30001	0
1	Measurement Wide Range ORP (mV)	0..20,000	-2,000.0 to +2,000.0	30001	0
1	Measurement Dissolved Oxygen (DO) - ppm	0..15,000	0.00 to 150.00	30001	0
1	Measurement Ion Selective in pION Units	0..18,000	-2.000 to +16.000	30001	0
1	Measurement Temperedated Compensated Conductivity (EC)	0..50,000	See HiQDT Modbus Implementation Guide	30001	0
2	Measurement °C	0..2,500	-40.0 to +210.0 °C	30002	1
3	Measurement raw mV for pH & Std ORP & ISE	5,000..45,000 *	-1,000.0 to +1,000.0	30003	2
3	Measurement raw mV for Wide Range ORP	5,000..45,000 *	-2,000.0 to +2,000.0	30003	2
3	Measurement raw mV for Dissolved Oxygen	0..25,000	+0.00 to +250.00	30003	2
3	Measurement raw Conductivity	0..50,000	See HiQDT Modbus Implementation Guide	30003	2
4	Measurement raw °C	0..2,500 **	-40.0 to +210.0 °C	30004	3
5	Measurement DO - % Saturation with Salinity	0..15,000	0.0 to 1,500.0 %	30005	4
5	Measurement computed salinity when Conductivity Sensor Type 6 (Std/High Range)	0..50,000	0.000 to 50.000 PSU	30005	4
5	Measurement computed resistivity using linear temperature compensation scheme when Conductivity Sensor Type 7 Ultralow Range	0..50,000	0.000 to 50.000 MΩ	30005	4
6	Measurement DO - % Saturation w/o Salinity	0..15,000	0.0 to 1,500.0 %	30006	5
6	Measurement computed TDS NaCl, 442 or KCl when Conductivity Sensor Type 6 (Std/High)	0..50,000	0 to 100,00 ppm	30006	5
6	Measurement computed resistivity using special non-linear ultrapure water (UPW) temperature compensation scheme for Type 7 Ultralow Range	0..50,000	0.000 to 50.000 MΩ	30006	5
7	Sensor Connection Status	0,1	0 = Not Connected, 1 = Connected	30007	6
8	mA Output Value from 3TX-RTU Transmitter	0..2,000	0.00 to 20.00	30008	7

i.e. <node> <code> <index> <#values>

* When raw mV is below engineered value limit, then this is indicated by the integer 4,999 being sent for this index.

* When raw mV is above engineered value limit, then this is indicated by the integer 45,001 being sent for this index.

** When raw °C is above engineered value limit, then this is indicated by the integer 2,501 being sent for this index.

NOTE FOR HiQDT-ISE Ion Selective Sensors:

Please Appendix 0 in HiQDT MODBUS implementation guide for instructions on how to convert from the scientific pION units used by this sensor to the common ppm units. The analog output scaling setpoints are sent in % of full scale corresponding to pION units.

NOTE FOR HiQDT-CON-ISO Conductivity Standard/High Range Type Sensors:

The type of TDS ppm units which are computed is defined by user register 40020 and the default is defined by system register 40051

GENERAL NOTE 1:

Please refer to the "IMPLEMENTATION OF HiQDT SMART DIGITAL RS-485 MODBUS RTU SENSORS WITH CUSTOMER PLC" modbus implementation guide for the overall MODBUS RTU communication setup as well as implementation approach # 2 that provide the details to access all smart analytic & calibration information for the smart sensor connected to the 3TX-RTU-D transmitter.

GENERAL NOTE 2:

Please refer to the implementation approach # 3 on "IMPLEMENTATION OF HiQDT SMART DIGITAL RS-485 MODBUS RTU SENSORS WITH CUSTOMER PLC" modbus implementation guide if you plan to implement any functionality that requires writing to the connected sensor. This requires that the P24 security feature is set to "All" to enable writing to the connected sensor.

Display Features

- **For Sensor Type 1 pH** - the “pH / ORP” LED will be continuous illuminated unless otherwise indicated below
 - -2.00 to -0.01 displayed as 2.00 to 0.01 flashing
 - 0.00 to 9.99 displayed not flashing with two decimal points
 - 10.0 to 16.0 display with one decimal point
 - If the ‘Down’ button is pressed, then the temperature of connected sensor is shown *
 - If ‘Down’ button is held for 3 to 5 seconds, then the absolute mV will be shown *
 - If the ‘Up’ button is pressed, then the mA for the current process value and scaling will be shown
- **For Sensor Type 2 ORP** - the “pH / ORP” LED will be continuous illuminated unless otherwise indicated below
 - -999 to -1 displayed as 999 to 1 flashing
 - 0 to +999 displayed not flashing
 - If the ‘Down’ button is pressed, then the temperature of connected sensor is shown *
 - If ‘Down’ button is held for 3 to 5 seconds, then the absolute mV will be shown *
 - If the ‘Up’ button is pressed, then the mA for the current process value and scaling will be shown
- **For Sensor Type 3 Wide ORP** - the “pH / ORP” LED will be continuous illuminated unless otherwise indicated below
 - -2,000 to -1,000 display as 2.00 to 1.00 with LED flashing (units are Volts)
 - -999 to -1 displayed as 999 to 1 flashing
 - 0 to +999 displayed not flashing
 - +1,000 to +2,000 display as 1.00 to 2.00 with LED not flashing (units are Volts)
 - If the ‘Down’ button is pressed, then the temperature of connected sensor is shown *
 - If ‘Down’ button is held for 3 to 5 seconds, then the absolute mV will be shown *
 - If the ‘Up’ button is pressed, then the mA for the current process value and scaling will be shown
- **For Sensor Type 4 Dissolved Oxygen (D.O.)** - the “D.O.” LED will be continuous illuminated unless otherwise indicated below
 - If P10 is ‘ppm’ then 0.00 to 150.00 ppm units displayed not flashing as 0.00 to 9.99, 10.0-99.9 and 100-150 ppm
 - If P10 is ‘%Sat’ then 0.0-1,500.0 percent (%) saturation units displayed not flashing as 0.0-99.9%, 100-999% with the special range of 1,000-1,500% displayed as 1.00-1.50 with LED flashing (kilo % Saturation Units)
 - If the ‘Down’ button is pressed, then the temperature of connected sensor is shown *
 - If ‘Down’ button is held for 3 to 5 seconds, then the absolute mV will be shown *
 - If the ‘Up’ button is pressed, then the mA for the current process value and scaling will be shown
 - If ‘Up’ button held and P10 is ‘ppm’ (basis of 4-20mA output) then % Saturation units are displayed
 - If ‘Up’ button held and P10 is ‘%Sat’ (basis of 4-20mA output) then ppm units are displayed
- **For Sensor Type 5 Ion Selective (ISE)** - the “ISE” LED will be continuous illuminated unless otherwise indicated below
 - 0.00-9.99, 10.0-99.9, 100-999 ppm units displayed same as per 3TX-ISE transmitter
 - **kilo-ppm units displayed with LED flashing to signify kilo-ppm scale is in use same as per 3TX-ISE-kilo**
 - 1.00-9.99 (1,000-9,990 ppm), 10.0-99.9 (10,000-99,900 ppm) and 100-999 (100,000-999,000 ppm)
 - If the ‘Down’ button is pressed, then the temperature of connected sensor is shown *
 - If ‘Down’ button is held for 3 to 5 seconds, then the absolute mV will be shown *
 - If the ‘Up’ button is pressed, then the mA for the current process value and scaling will be shown
 - If ‘Up’ button held for 3 to 5 seconds, pION value is shown with same scheme used display the pH
- **For Sensor Type 6 or 7 Conductivity (EC)** - the “Cond” LED will be continuous illuminated unless otherwise indicated below
 - **<1.00 mS shown as flashing** from 1 to 999 uS/cm with 0.01-9.99, 10.0-99.9 and 100-999 floating decimal point
 - 1.00 to 999 mS/cm shown displayed not flashing with 0.01-9.99, 10.0-99.9 and 100-999 floating decimal point
 - **1,000 to 2,000 mS/cm display as 1.00 to 2.00 with the LED flashing (kilo-mS/cm)**
 - If P11 is ‘PSU or MΩ’ then salinity (sensor type 6) or resistivity (sensor type 7) is shown as 0.00-9.99 and 10.0-50.0
 - If P11 is ‘TDS’ then ppt is shown as 0.00-9.99 and 10.0-99.9 (multiply by 1,000 to get ppm units instead of ppt units)
 - If the ‘Down’ button is pressed, then the temperature of connected sensor is shown *
 - If ‘Down’ button is held for 3 to 5 seconds, then raw conductivity will be shown per scheme above
 - If the ‘Up’ button is pressed, then the mA for the current process value and scaling will be shown
 - If ‘Up’ button is held for 3 to 5 seconds and P11 is ‘PSU’, ‘TDS’ or ‘MΩ’ then reading in conductivity units will be shown (see scheme above). If conductivity units selected for P11 then nothing is shown.
- Production data (yy.m) displayed by pressing ‘Down’ & ‘Mode’ “Mode” simultaneously in any main LED display mode. The month will display as 1..9 and then A for October, B for November and C for December. I.e. October 2011 will display as “11.A”.
- Revision of software is displayed by pressing the ‘Up’ ‘Mode’ simultaneously in any main display mode.

* Negative values will be shown as flashing.



ORDERING INFO FOR 3TX-RTU-D UNIVERSAL SMART TRANSMITTERS

ENCLOSURE TYPE CODING & DETAILED DESCRIPTION	
CODE	DESCRIPTION
3TX-0M	3TX Transmitter with No Enclosure
3TX-DIN	3TX Transmitter with No Enclosure; Preinstalled onto 35mm DIN-Rail
3TX-2MW	3TX Transmitter(s) in IP65 Enclosure; Up to 2 Total Modules (Wall Installations Only)
3TX-2M	3TX Transmitter(s) in IP65 Enclosure; Up to 2 Total Modules (Wall or Pipe Installations)
3TX-3MP	3TX Transmitter(s) in NEMA 4X CSA/UL Rated Enclosure; ½-DIN Panel ; Max 3 Modules (Panel Bracket assy)
3TX-3MF	3TX Transmitter(s) in NEMA 4X CSA/UL Rated Enclosure; Up to 3 Total Modules (Wall or Pipe Installations)
3TX-4MW	3TX Transmitter(s) in IP65 Enclosure; Up to 4 Total Modules (Wall Installations Only)
3TX-4M	3TX Transmitter(s) in IP65 Enclosure; Up to 4 Total Modules (Wall or Pipe Installations)
3TX-5MF	3TX Transmitter(s) in NEMA 4X CSA/UL Rated Enclosure; Up to 5 Total Modules (Wall or Pipe Installations)
3TX-6MW ***	3TX Transmitter(s) in IP65 Enclosure; Up to 6 Total Modules (Wall or Pipe Installations)
3TX-6M ***	3TX Transmitter(s) in IP65 Enclosure; Up to 6 Total Modules (Wall or Pipe Installations)
3TX-7MF ***	3TX Transmitter(s) in NEMA 4X CSA/UL Rated Enclosure; Up to 7 Total Modules (Wall or Pipe Installations)
3TX-9MF ***	3TX Transmitter(s) in NEMA 4X CSA/UL Rated Enclosure; Up to 9 Total Modules (Wall or Pipe Installations)
MEASUREMENT MODULES (FROM 1 TO 9 TOTAL, PRICE IS PER EACH MODULE)	
CODE	DESCRIPTION
-RTU-D- TYPE	Universal Transmitter for Use with Smart Digital HiQDT MODBUS RTU pH, ORP, DO, ISE & Conductivity Sensors Standard with isolated, scalable & reversible 0-20mA or 4-20mA analog current loop output & RS-485 MODBUS RTU TYPE : The default sensor type and all user configurable parameters can be customized to be any values of desired so long as this is done at time of order. Upon reset of transmitter default values requested at time of order will be restored.
ADD-ON MODULES FOR MEASUREMENT MODULES IN ENCLOSURE ASSEMBLIES	
CODE	DESCRIPTION
-PS	100 to 240 VAC 50/60 Hz Universal Power Supply Adapter for Line Powered Operation
-PS/BAT	Dual Isolated & Regulated 24VDC Power Supply Converter for operation from 5V Batteries or USB Power Supply
-SW	On/Off Power Switch (½ Width of power supply module and ¼ width of standard 3TX transmitter)
-REL	Programmable Alarm & Relay Controller with tight integration with all 3TX measurement modules for easy setup Standard with simple supervision, On/Off, Time Proportional Control (TPC) or Variable Pulse Control Modes
-TOT	pH compensated "Total ISE" from ISE & pH inputs, 0/4-20mA analog & MODbus digital outputs

2" NPT Pipe mounting bracket kits supplied separately. For 3MP, 3MF, 6MW & 7MF enclosures the power supply is not counted as a module for space purposes. Refer to documentation for 3TX transmitter for use with analog sensors for all 3TX measurement modules not listed here. 3TX transmitter measurement modules for analog sensors and the 3TX-RTU & 3TX-HiQ transmitter modules for smart digital sensors can be mixed and matched into any enclosure without limitation. The female panel mount snap connector is only available for the 3TX-RTU & 3TX-HiQ-pH transmitters.

- * Enclosures standard with ½" MNPT cable glands for sensor inputs & transmitter outputs. Base enclosure cost includes this feature standard.
- ** Enclosures for use with 3TX-RTU can be supplied with female panel mount snap connector installed into the input side of the enclosure as an option. This option is designated by adding -XH to the end of the enclosure part number where X is the number of female panel mount snap connectors desired for the given enclosure. There exists a surcharge to the base enclosure cost for each snap connector that is installed. The number of snap connector cannot exceed the number of 3TX modules supported for the enclosure type. Examples are given below for elucidation of this -XH snap connector female panel mount option available for the HiQ digital sensors. The standard cable gland and snap connector inputs can be mixed and matched as desired. Analog 3TX transmitter can likewise be mixed and matched with digital 3TX-HiQ style transmitter modules although the snap input option is only supported on the 3TX-RTU & 3TX-HiQ-pH transmitters. All seals for the transmitter outputs are always cable glands.

*** For 2" NPT pipe mounting additional adapter plate is required for 6MW, 6M, 7MF & 9MF enclosures. The 2M, 4M, 3MF & 5MF enclosures support pipe mounting without adapter plate while 2MW, 4MW, 6MW & 3MP enclosures are not supported for pipe mounting (not even with adapter plate).

Model: **3TX-2MW-H-RTU-pH-REL**

Description: Single Channel Controller in IP65 Weatherproof Enclosure; 1 each female snap panel mount connectors installed ready for HiQDT sensors; 3TX-RTU Universal transmitters preconfigured for pH with 3TX-REL alarm/relay controller module; No AC Power Supply, 3-wire 24VDC Powered

Model: **3TX-3MF-3H-RTU-DO-SAT-RTU-CON-PSU-RTU-ORP-PS-SW**

Description: Triple Channel Transmitter Assembly in NEMA 4X CSA/UL rated Enclosure for Wall or Pipe Mounting Installations with 3 each 3TX-RTU Universal transmitter preconfigured for dissolved oxygen sensor using computed percent (%) saturation units and conductivity sensor using salinity PSU units and ORP sensor for main LED display and analog outputs; Universal 100-240 VAC Power Supply; On/Off Toggle Power Switch

Model: **3TX-6MW-4H-RTU-ISE-RTU-pH-TOT-NH3-RTU-DO-ppm-RTU-CON-PS**

Description: Four Channel Measurement Transmitter Assy in IP65 Weatherproof Enclosure (Max 6 Modules); 3 each 3TX-RTU Universal transmitters preconfigured for use with ion selective sensor, pH sensor, dissolved oxygen sensor in ppm mode and conductivity sensor in uS/cm or mS/cm units plus 1 each TOT module to compute total ammonia (NH₃+NH₄⁺) from ammonium & pH sensor inputs; Universal 100-240 VAC Power Supply included

Last Modified February 20, 2023 | Revision 13

Measurement Configuration	pH	Setup Parameter
Sensor Type	1	N/A
Default Node	1	P18
Default Baudrate	19,200	P02
Default Output Type	4-20mA	P03
Default Polarity	non-inverted	P04
Default Low Whole	11	P05
Default Low Decimal	11	P06
Default Hi Whole	88	P07
Default Hi Decimal	89	P08
Days to Recalibrate	14	P09
		P17

Integer Limits	Engineered pH Limits
0	-2.000
18,000	16.000

% of Full Range	Engineered pH Units	RTU Integer
0.00%	-2.000	0
5.56%	-1.000	1000
11.11%	0.000	2000
16.67%	1.000	3000
22.22%	2.000	4000
27.78%	3.000	5000
33.33%	4.000	6000
38.89%	5.000	7000
44.44%	6.000	8000
50.00%	7.000	9000
55.56%	8.000	10000
61.11%	9.000	11000
66.67%	10.000	12000
72.22%	11.000	13000
77.78%	12.000	14000
83.33%	13.000	15000
88.89%	14.000	16000
94.44%	15.000	17000
100.00%	16.000	18000

11.11%	0.000	Default Low Setpoint	P06/P07
88.89%	14.000	Default High Setpoint	P08/P09

CHANGING pH VALUE ABOVE GET % SCALING COMPUTED

NOTE 1: Low & High Analog Setpoints should be at least 1,000 MODBUS RTU steps apart.

Measurement Configuration	ORP	Setup Parameter
Sensor Type	2	N/A
Default Node	2	P18
Default Baudrate	19,200	P02
Default Output Type	4-20mA	P03
Default Polarity	non-inverted	P04
Default Low Whole	0	P05
Default Low Decimal	0	P06
Default Hi Whole	100	P07
Default Hi Decimal	0	P08
Days to Recalibrate	30	P09
		P17

Integer Limits	Engineered ORP Limits
0	-1,000.0
20,000	1,000.0

% of Full Range	Engineered ORP Units	RTU Integer
0.00%	-1,000.0	0
5.00%	-900.0	1000
10.00%	-800.0	2000
15.00%	-700.0	3000
20.00%	-600.0	4000
25.00%	-500.0	5000
30.00%	-400.0	6000
35.00%	-300.0	7000
40.00%	-200.0	8000
45.00%	-100.0	9000
50.00%	0.0	10000
55.00%	100.0	11000
60.00%	200.0	12000
65.00%	300.0	13000
70.00%	400.0	14000
75.00%	500.0	15000
80.00%	600.0	16000
85.00%	700.0	17000
90.00%	800.0	18000
95.00%	900.0	19000
100.00%	1,000.0	20000

0.00%	-1,000.0	Default Low Setpoint	P06/P07
100.00%	1,000.0	Default High Setpoint	P08/P09

CHANGING ORP VALUE ABOVE GET % SCALING COMPUTED

NOTE 1: Low & High Analog Setpoints should be at least 1,000 MODBUS RTU steps apart.

Measurement Configuration	Wide ORP	Setup Parameter
Sensor Type	3	N/A
Default Node	3	P18
Default Baudrate	19,200	P02
Default Output Type	4-20mA	P03
Default Polarity	non-inverted	P04
Default Low Whole	0	P05
Default Low Decimal	0	P06
Default Hi Whole	100	P07
Default Hi Decimal	0	P08
Days to Recalibrate	30	P09
		P17

Integer Limits	Engineered ORP Limits
0	-2,000.0
20,000	2,000.0

% of Full Range	Engineered ORP Units	RTU Integer
0.00%	-2,000.0	0
5.00%	-1,800.0	1000
10.00%	-1,600.0	2000
15.00%	-1,400.0	3000
20.00%	-1,200.0	4000
25.00%	-1,000.0	5000
30.00%	-800.0	6000
35.00%	-600.0	7000
40.00%	-400.0	8000
45.00%	-200.0	9000
50.00%	0.0	10000
55.00%	200.0	11000
60.00%	400.0	12000
65.00%	600.0	13000
70.00%	800.0	14000
75.00%	1,000.0	15000
80.00%	1,200.0	16000
85.00%	1,400.0	17000
90.00%	1,600.0	18000
95.00%	1,800.0	19000
100.00%	2,000.0	20000

0.00%	-2,000.0	Default Low Setpoint	P06/P07
100.00%	2,000.0	Default High Setpoint	P08/P09

CHANGING ORP VALUE ABOVE GET % SCALING COMPUTED

NOTE 1: Low & High Analog Setpoints should be at least 1,000 MODBUS RTU steps apart.

Measurement Configuration	Dissolved Oxygen ppm	Setup Parameter
Sensor Type	4	N/A
Default Node	4	P18
Default Baudrate	19,200	P02
Default Output Type	4-20mA	P03
Default Polarity	non-inverted	P04
Default Low Whole	0	P05
Default Low Decimal	0	P06
Default Hi Whole	100	P07
Default Hi Decimal	0	P08
Days to Recalibrate	30	P09
DO Units for Output	ppm	P17
		P10

Integer Limits	Engineered DO ppm Limits
0	0.00
15,000	150.00

% of Full Range	Engineered DO ppm Units	RTU Integer
0.00%	0.00	0
6.67%	10.00	1000
13.33%	20.00	2000
20.00%	30.00	3000
26.67%	40.00	4000
33.33%	50.00	5000
40.00%	60.00	6000
46.67%	70.00	7000
53.33%	80.00	8000
60.00%	90.00	9000
66.67%	100.00	10000
73.33%	110.00	11000
80.00%	120.00	12000
86.67%	130.00	13000
93.33%	140.00	14000
100.00%	150.00	15000

0.00%	0.00	Default Low Setpoint	P06/P07
100.00%	150.00	Default High Setpoint	P08/P09

CHANGING DO ppm VALUE ABOVE GET % SCALING COMPUTED

NOTE 1: Low & High Analog Setpoints should be at least 1,000 MODBUS RTU steps apart.

Measurement Configuration	Dissolved Oxygen % Saturation	Setup Parameter
Sensor Type	5	N/A
Default Node	4	P18
Default Baudrate	4	P02
Default Output Type	19,200	P03
Default Polarity	4-20mA	P04
Default Low Whole	non-inverted	P05
Default Low Decimal	0	P06
Default Hi Whole	0	P07
Default Hi Decimal	100	P08
Days to Recalibrate	0	P09
DO Units for Output	30	P17
% Sat with Salinity Correction		P10

Integer Limits	Engineered DO % Sat Limits
0	0.0
15,000	1,500.0

% of Full Range	Engineered DO % Sat Units	RTU Integer
0.00%	0.0	0
6.67%	100.0	1000
13.33%	200.0	2000
20.00%	300.0	3000
26.67%	400.0	4000
33.33%	500.0	5000
40.00%	600.0	6000
46.67%	700.0	7000
53.33%	800.0	8000
60.00%	900.0	9000
66.67%	1,000.0	10000
73.33%	1,100.0	11000
80.00%	1,200.0	12000
86.67%	1,300.0	13000
93.33%	1,400.0	14000
100.00%	1,500.0	15000

0.00%	0.0	Default Low Setpoint	P06/P07
100.00%	1,500.0	Default High Setpoint	P08/P09

CHANGING DO % SATURATION VALUE ABOVE GET % SCALING COMPUTED

NOTE 1: Low & High Analog Setpoints should be at least 1,000 MODBUS RTU steps apart.

Measurement Configuration	ISE	Setup Parameter	NOTE
Sensor Type	5	N/A	Read Only Adjustable from 01 to 247 9,600 or 19,200 0-20mA or 4-20mA non-inverted or inverted See notes below for limits See notes below for limits See notes below for limits
Default Node	5	P18	
Default Baudrate	19,200	P02	
Default Output Type	4-20mA	P03	
Default Polarity	non inverted	P04	
Default Low Whole	22	P05	
Default Low Decimal	22	P06	
Default Hi Whole	44	P07	
Default Hi Decimal	44	P08	
		P09	

**CHANGE VALUE BELOW TO MATCH
P19 FROM 3TX-RTU-D TRANSMITTER AFTER ISE
SENSOR IS CONNECTED & NODE IS CONFIGURED**

Integer Limits	Engineered pION Limits
0	-2.000
18,000	16.000

if P19 Value is: **19.00**

THEN OUTPUT IS FOR FLUORIDE

% of Full Range	Engineered pION Units	RTU Integer	ppm units
0.00%	-2.000	0	1900000
5.56%	-1.000	1000	190000
11.11%	0.000	2000	19000
16.67%	1.000	3000	1900
22.22%	2.000	4000	190
27.78%	3.000	5000	19
33.33%	4.000	6000	1.9
38.89%	5.000	7000	0.19
44.44%	6.000	8000	0.019
50.00%	7.000	9000	0.0019
55.56%	8.000	10000	0.00019
61.11%	9.000	11000	0.000019

44.44%	6.000
22.22%	2.000

**% FULL RANGE COMPUTED FOR PPM
VALUES ENTERED TO THE RIGHT**

ppm Low Set
ppm High Set

0.01900	P08/P09
190.00000	P06/P07

**CHANGE ppm VALUES ABOVE
TO DESIRED VALUES FOR
LOW & HIGH SETPOINTS**

44.44%	6.000	Default High Setpoint in pION (Low Setpoint in ppm)
22.22%	2.000	Default Low Setpoint in pION (High Setpoint in ppm)

NOTE 1: Low & High Analog Setpoints should be at least 1,000 MODBUS RTU steps apart.
NOTE 2: 0 ppm not a valid number for low setpoint since there exists no corresponding pION value.
NOTE 3: The logic of the high & low setpoints is inverted because while they are set in pION units the analog output itself is linear in ppm units. That is to say that the "high setpoint" in pION units is really the "low setpoint" in ppm units. Conversely the "low setpoint" in PION units is then really the "high setpoint" in ppm units. Contact factory if there should be any questions or concerns.

Measurement	ISE	Setup Parameter	NOTE
Configuration	6	N/A	
Sensor Type	5	P18	Read Only
Default Node	5	P02	Adjustable from 01 to 247
Default Baudrate	19,200	P03	9,600 or 19,200
Default Output Type	4-20mA	P04	0-20mA or 4-20mA
Default Polarity	non inverted	P05	non-inverted or inverted
Default Low Whole	22	P06	See notes below for limits
Default Low Decimal	22	P07	See notes below for limits
Default Hi Whole	44	P08	See notes below for limits
Default Hi Decimal	44	P09	See notes below for limits

**CHANGE VALUE BELOW TO MATCH
P19 FROM 3TX-RTU-D TRANSMITTER AFTER ISE
SENSOR IS CONNECTED & NODE IS CONFIGURED**

Integer Limits	Engineered pION Limits
0	-2.000
18,000	16.000

if P19 Value is: **18.04**

THEN OUTPUT IS FOR AMMONIUM

% of Full Range	Engineered pION Units	RTU Integer	ppm units
0.00%	-2.000	0	1804000
5.56%	-1.000	1000	180400
11.11%	0.000	2000	18040
16.67%	1.000	3000	1804
22.22%	2.000	4000	180.4
27.78%	3.000	5000	18.04
33.33%	4.000	6000	1.804
38.89%	5.000	7000	0.1804
44.44%	6.000	8000	0.01804
50.00%	7.000	9000	0.001804
55.56%	8.000	10000	0.0001804
61.11%	9.000	11000	0.00001804

44.44%	6.000
22.22%	2.000

ppm Low Set
ppm High Set

0.01804	P08/P09
180.40000	P06/P07

**% FULL RANGE COMPUTED FOR PPM
VALUES ENTERED TO THE RIGHT**

**CHANGE ppm VALUES ABOVE
TO DESIRED VALUES FOR
LOW & HIGH SETPOINTS**

44.39%	5.991	Default High Setpoint in pION (Low Setpoint in ppm)
22.22%	2.000	Default Low Setpoint in pION (High Setpoint in ppm)

NOTE 1: Low & High Analog Setpoints should be at least 1,000 MODBUS RTU steps apart.
NOTE 2: 0 ppm not a valid number for low setpoint since there exists no corresponding pION value.
NOTE 3: The logic of the high & low setpoints is inverted because while they are set in pION units the analog output itself is linear in ppm units. That is to say that the "high setpoint" in pION units is really the "low setpoint" in ppm units. Conversely the "low setpoint" in PION units is then really the "high setpoint" in ppm units. Contact factory if there should be any questions or concerns.

Measurement	ISE	Setup Parameter	NOTE
Configuration	6	N/A	
Sensor Type	5	P18	Read Only
Default Node	5	P02	Adjustable from 01 to 247
Default Baudrate	19,200	P03	9,600 or 19,200
Default Output Type	4-20mA	P04	0-20mA or 4-20mA
Default Polarity	non inverted	P05	non-inverted or inverted
Default Low Whole	22	P06	See notes below for limits
Default Low Decimal	22	P07	See notes below for limits
Default Hi Whole	44	P08	See notes below for limits
Default Hi Decimal	44	P09	See notes below for limits

**CHANGE VALUE BELOW TO MATCH
P19 FROM 3TX-RTU-D TRANSMITTER AFTER ISE
SENSOR IS CONNECTED & NODE IS CONFIGURED**

Integer Limits	Engineered pION Limits
0	-2.000
18,000	16.000

if P19 Value is: **40.08**

THEN OUTPUT IS FOR CALCIUM

% of Full Range	Engineered pION Units	RTU Integer	ppm units
0.00%	-2.000	0	4008000
5.56%	-1.000	1000	400800
11.11%	0.000	2000	40080
16.67%	1.000	3000	4008
22.22%	2.000	4000	400.8
27.78%	3.000	5000	40.08
33.33%	4.000	6000	4.008
38.89%	5.000	7000	0.4008
44.44%	6.000	8000	0.04008
50.00%	7.000	9000	0.004008
55.56%	8.000	10000	0.0004008
61.11%	9.000	11000	0.00004008

44.44%	6.000
22.22%	2.000

ppm Low Set
ppm High Set

0.04008	P08/P09
400.80000	P06/P07

**% FULL RANGE COMPUTED FOR PPM
VALUES ENTERED TO THE RIGHT**

**CHANGE ppm VALUES ABOVE
TO DESIRED VALUES FOR
LOW & HIGH SETPOINTS**

44.44%	6.000	Default High Setpoint in pION (Low Setpoint in ppm)
22.22%	2.000	Default Low Setpoint in pION (High Setpoint in ppm)

NOTE 1: Low & High Analog Setpoints should be at least 1,000 MODBUS RTU steps apart.
NOTE 2: 0 ppm not a valid number for low setpoint since there exists no corresponding pION value.
NOTE 3: The logic of the high & low setpoints is inverted because while they are set in pION units the analog output itself is linear in ppm units. That is to say that the "high setpoint" in pION units is really the "low setpoint" in ppm units. Conversely the "low setpoint" in PION units is then really the "high setpoint" in ppm units. Contact factory if there should be any questions or concerns.

Measurement Configuration	Conductivity	Setup Parameter
Sensor Type	7	N/A
Default Node	6 or 7 or 9	P18
Default Baudrate	6	P02
Default Output Type	19,200	P03
Default Polarity	4-20mA	P04
Default Low Whole	non-inverted	P05
Default Low Decimal	0	P06
Default Hi Whole	0	P07
Default Hi Decimal	100	P08
Days to Recalibrate	0	P09
Units for Output	90	P17
	Con	P11

STANDARD RANGE MODE * - All values are given in microSiemens/cm

Range Scaling Factor	200	P13		P06/P07		P08/P09
Cell Constant P12	Max Conductivity	Resolution	0/4mA Low Setpoint	% of Full Range	20mA High Setpoint	% of Full Range
0.01	200	0.004	0.00	0.00%	200.00	100.00%
0.02	400	0.008	0.00	0.00%	400.00	100.00%
0.05	1,000	0.02	0.00	0.00%	1,000.00	100.00%
0.10	2,000	0.04	0.00	0.00%	2,000.00	100.00%
0.20	4,000	0.08	0.00	0.00%	4,000.00	100.00%
0.50	10,000	0.2	0.00	0.00%	10,000.00	100.00%
1.00	20,000	0.4	0.00	0.00%	20,000.00	100.00%
2.00	40,000	0.8	0.00	0.00%	40,000.00	100.00%
3.00	60,000	1.2	0.00	0.00%	60,000.00	100.00%
5.00	100,000	2	0.00	0.00%	100,000.00	100.00%
10.00	200,000	4	0.00	0.00%	200,000.00	100.00%
20.00	400,000	8	0.00	0.00%	400,000.00	100.00%

HIGH RANGE MODE * - All values are given in microSiemens/cm

Range Scaling Factor	2,000	P13		P06/P07		P08/P09
Cell Constant P12	Max Conductivity	Resolution	0/4mA Low Setpoint	% of Full Range	20mA High Setpoint	% of Full Range
0.01	2,000	0.04	0.00	0.00%	1,000.00	50.00%
0.02	4,000	0.08	0.00	0.00%	2,000.00	50.00%
0.05	10,000	0.2	0.00	0.00%	5,000.00	50.00%
0.10	20,000	0.4	0.00	0.00%	10,000.00	50.00%
0.20	40,000	0.8	0.00	0.00%	20,000.00	50.00%
0.50	100,000	2	0.00	0.00%	50,000.00	50.00%
1.00	200,000	4	0.00	0.00%	100,000.00	50.00%
2.00	400,000	8	0.00	0.00%	200,000.00	50.00%
3.00	600,000	12	0.00	0.00%	300,000.00	50.00%
5.00	1,000,000	20	0.00	0.00%	500,000.00	50.00%
10.00	2,000,000	40	0.00	0.00%	1,000,000.00	50.00%
20.00	4,000,000	80	0.00	0.00%	2,000,000.00	50.00%

ULTRALOW RANGE MODE * - All values are given in microSiemens/cm

Range Scaling Factor	2	P13		P06/P07		P08/P09
Cell Constant P12	Max Conductivity	Resolution	0/4mA Low Setpoint	% of Full Range	20mA High Setpoint	% of Full Range
0.01	2	0.00004	0.00	0.00%	2.00	100.00%
0.02	4	0.00008	0.00	0.00%	4.00	100.00%
0.05	10	0.0002	0.00	0.00%	10.00	100.00%
0.10	20	0.0004	0.00	0.00%	20.00	100.00%
0.20	40	0.0008	0.00	0.00%	40.00	100.00%
0.50	100	0.002	0.00	0.00%	100.00	100.00%
1.00	200	0.004	0.00	0.00%	200.00	100.00%
2.00	400	0.008	0.00	0.00%	400.00	100.00%
3.00	600	0.012	0.00	0.00%	600.00	100.00%
5.00	1,000	0.02	0.00	0.00%	1,000.00	100.00%
10.00	2,000	0.04	0.00	0.00%	2,000.00	100.00%
20.00	4,000	0.08	0.00	0.00%	4,000.00	100.00%

NOTE 1: Difference between Low & High Analog Setpoints should be at least 2% of the Full Range Apart

NOTE 2: Minimum Recommend Scaling is 4.00% of the full range if the low setpoint is 0.00%.

NOTE 3: For High Range Mode the maximum recommended High 20mA Setpoint is 50% of Full Range

Measurement Configuration	Conductivity	Setup Parameter
Sensor Type	8	N/A
Default Node	6 or 7 or 9	P18
Default Baudrate	6	P02
Default Output Type	19,200	P03
Default Polarity	4-20mA	P04
Default Low Whole	non-inverted	P05
Default Low Decimal	0	P06
Default Hi Whole	0	P07
Default Hi Decimal	100	P08
Days to Recalibrate	0	P09
Units for Output	90	P17
	PSU or MegaOhm	P11

Integer Limits	Engineered PSU / MOhm Limits
0	0.000
50,000	50.000

% of Full Range	Engineered PSU / MOhm Units	RTU Integer
0.00%	0.000	0
10.00%	5.000	5000
20.00%	10.000	10000
30.00%	15.000	15000
40.00%	20.000	20000
50.00%	25.000	25000
60.00%	30.000	30000
70.00%	35.000	35000
80.00%	40.000	40000
90.00%	45.000	45000
100.00%	50.000	50000

0.00%	0.000	Default Low Setpoint	P06/P07
100.00%	50.000	Default High Setpoint	P08/P09
CHANGING PSU VALUES GET % SCALING COMPUTED (SENSOR TYPE 6)			

0.00%	0.000	Default Low Setpoint	P06/P07
40.00%	20.000	Default High Setpoint	P08/P09
CHANGING MOhm VALUES GET % SCALING COMPUTED (SENSOR TYPE 7)			

NOTE 1: Low & High Analog Setpoints should be at least 1,000 MODBUS RTU steps apart.

NOTE 2: Units are PSU for Sensor Type 6 or 9 and MegaOhms for Sensor Type 7

Measurement Configuration	Conductivity	Setup Parameter
Sensor Type	9	N/A
Default Node	6 or 7 or 9	P18
Default Baudrate	6	P02
Default Output Type	19,200	P03
Default Polarity	4-20mA	P04
Default Low Whole	non-inverted	P05
Default Low Decimal	0	P06
Default Hi Whole	0	P07
Default Hi Decimal	100	P08
Days to Recalibrate	0	P09
Units for Output	90	P17
	TDS or MegaOhms for UPW	P11

Integer Limits	Engineered TDS ppm Limits	Engineered TDS ppt Limits
0	0	0.00
50,000	100,000	100.00

% of Full Range	Engineered TDS Units	RTU Integer
0.00%	0	0
5.00%	5,000	2500
10.00%	10,000	5000
15.00%	15,000	7500
20.00%	20,000	10000
25.00%	25,000	12500
30.00%	30,000	15000
35.00%	35,000	17500
40.00%	40,000	20000
45.00%	45,000	22500
50.00%	50,000	25000
55.00%	55,000	27500
60.00%	60,000	30000
65.00%	65,000	32500
70.00%	70,000	35000
75.00%	75,000	37500
80.00%	80,000	40000
85.00%	85,000	42500
90.00%	90,000	45000
95.00%	95,000	47500
100.00%	100,000	50000

0.00%	0	Default Low Setpoint	P06/P07
100.00%	100,000	Default High Setpoint	P08/P09

CHANGING TDS VALUE ABOVE GET % SCALING COMPUTED

NOTE 1: Low & High Analog Setpoints should be at least 1,000 MODBUS RTU steps apart.

NOTE 2: Units are TDS for Sensor Type 6 or 9 and MegaOhms for UPW for Sensor Type 7

Integer Limits	Engineered MOhm for UPW Limits
0	0.000
50,000	50.000

% of Full Range	Engineered MOhm for UPW Units	RTU Integer
0.00%	0.000	0
10.00%	5.000	5000
20.00%	10.000	10000
30.00%	15.000	15000
40.00%	20.000	20000
50.00%	25.000	25000
60.00%	30.000	30000
70.00%	35.000	35000
80.00%	40.000	40000
90.00%	45.000	45000
100.00%	50.000	50000

0.00%	0.000	Default Low Setpoint	P06/P07
40.00%	20.000	Default High Setpoint	P08/P09

CHANGING MOhm FOR UPW VALUE ABOVE GET % SCALING COMPUTED

NOTE 1: Low & High Analog Setpoints should be at least 1,000 MODBUS RTU steps apart.

NOTE 2: Units are TDS for Sensor Type 6 or 9 and MegaOhms for UPW for Sensor Type 7