

## 3TX-HiQ Intelligent Transmitters for Smart Digital Sensors Measurement Platform Alternate Field Installation Guide

### Tinned leads to the 3TX-HiQ from Bridge Box:

- Tinned leads to tinned leads cable extensions with cable glands installed into transmitter enclosure and bridge box ensure integrity of seal at both ends.
- The wiring to the 3TX-HiQ transmitter need be done only once. Subsequent sensor exchanges in field for cleaning, recalibration or replacement do not require contact with input terminals on the transmitter board.
- Smart digital sensors are installed and removed via HiQ4FP female panel mount snap connector interface on Bridge Box assembly (see photos on page X) for visualization of this alternate installation scheme.

### Wiring of Tinned Leads to 3TX-HiQ Transmitter

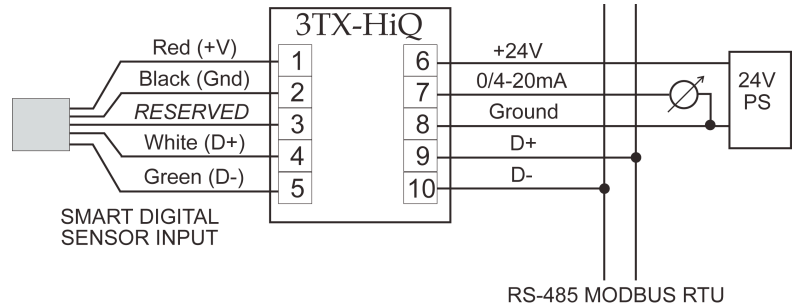

## FIELD INSTALLATION SCHEMES - PART 1

Please review the first two pages of the 3TX FAQ before wiring-up or powering on any of the 3TX modules.

Installation approaches for genuine Smart Digital IOTRON™ pH & ORP type HiQ sensors are detailed in the following pages.

### BASE HiQ pH & ORP SENSOR CONFIGURATION:

All smart digital IOTRON™ & ZEUS™ pH and ORP HiQ style sensors for use with 3TX-HiQ-pH transmitters come standard with 6 meters (20 feet) of integral cable and include quick disconnect male terminated IP67 & NEMA 6P rugged field ready connector. Shorter cable lengths of 1.5 meters (5 feet) and 3 meters (10 feet) are also available but there is no difference in cost for these shorter sensor cable lengths.

Installation requiring cable runs longer than 6 meters (20 feet) can be achieved using the approach #2 & #3 options for field installation detailed below. Best practice is to use the well stocked standard sensor cable lengths and cable extension options for the lowest cost and best availability of your 3TX-HiQ-pH installation. Longer cable lengths can also be achieved by use of the **special order options indicated in green** in PART 2 of this guide but this approach may lead to longer lead times for fabrication.

#### Approach # 1

*Directly connect male snap termination of smart sensor to female panel mount installed on bridge box assembly (see page 5)*

→ Length of cable ordered for sensor must be sufficient to interface to enclosure for this approach. Standard 6 meter length (20 feet) with optional shorter 3 meters (10 feet), 1.5 meters (5 foot) lengths also available for the exact same HiQ option adder cost.

#### Approach # 2

*Use snap to snap cable extensions terminating into female panel mount plug installed on bridge box assembly (see page 5)*

→ Length of cable between sensor and snap to snap cable extension(s) must be sufficient to interface to enclosure for this approach. The use of multiple snap to snap cable extensions is ASTI factory supported and will not result in signal degradation so long as the maximum 610 meters (2,000 feet) of total cable length is not exceeded.

#### Approach # 3

*Use female snap to tinned leads cable extensions terminating into terminals strip inside bridge box assembly (see page 6) or input terminals on 3TX-HiQ transmitter with cable glands installed into enclosure to ensure secure and waterproof connections*

→ Female snap to tinned lead cable extensions can be mated with the sensor male snap connector or else to a snap to snap cable extension. If the female snap to tinned leads cable extensions is employed, it should always be used as the final portion of the installation so that this cable interfaces the 3TX-HiQ transmitter input terminal board (see wiring schematic at top of page).

### GENERAL NOTE:

The sensor terminations are always male snap connector. The female snap to male snap cable extensions and female snap to tinned leads cable extensions can be used in any combination without signal degradation so long as the maximum supported 610 meters (2,000 feet) of total cable length is not exceeded in aggregate.



## ALTERNATE FIELD INSTALLATION SCHEMES - PART 2

Find detailed below the standard and special order cable length installation options using the HiQ smart digital platform.

### Integral Cable Length Options for HiQ Sensors

- All HiQ style sensors come standard with male snap connector. Standard integral cable length is 6 meters (20 feet).
- Shorter 3 meters (10 feet) or 1.5 meters (5 feet) integral sensor cable lengths also terminating with male snap connector available for same price as standard 6 meter (20 foot) length. Specify shorter lengths by -HiQ-1.5m or -HiQ-3.0m coding. If standard -HiQ option is invoked the sensor is supplied with standard 6 meters (20 feet) of cable & male snap connector.
- **12 meters (40 feet) of integral sensor cable with male snap connector available as a special order option (-HiQ-12m).**

### Female Snap to Male Snap Cable Extension Options

3 meters (10 feet)	HiQ4F-3m-HiQ4M
6 meters (20 feet)	HiQ4F-6m-HiQ4M
12 meters (40 feet)	HiQ4F-12m-HiQ4M
<b>24 meters (80 feet)</b>	<b>HiQ4F-24m-HiQ4M - Special Order Option Only</b>

### Female Snap to Tinned Leads Cable Extension Options

1.5 meters (5 feet)	HiQ4F-1.5m-TL
3 meters (10 feet)	HiQ4F-3m-TL
6 meters (20 feet)	HiQ4F-6m-TL
<b>12 meters (40 feet)</b>	<b>HiQ4F-12m-TL - Special Order Option Only</b>

### POSSIBLE TOTAL CABLE LENGTH INSTALLATIONS USING APPROACH #1, #2 or #3

**Approach # 1:** Sensor with integral cable only with male snap connected directly to female panel mount:  
STANDARD is 6m (20ft) with shorter 1.5 meters (5 feet), 3 meters (10 feet) cable lengths also available for same price  
→ **12m (40ft) integral cable length terminating with male snap connector also available as Special Order Option**

**Approach # 2:** Sensor with integral cable and female to male snap cable extension connected to female panel mount:

	<b>+3 meters</b>	<b>+6 meters</b>	<b>+12 meters</b>	<b>+24 meters</b>
With 1.5m (5ft) integral sensor cable:	4.5m (15 feet)	7.5m (15 feet)	13.5m (45 feet)	<b>25.5m (85 feet)</b>
With 3m (10 ft) integral sensor cable:	6.0m (20 feet)	9.0m (30 feet)	15m (50 feet)	<b>27.0m (90 feet)</b>
With 6m (20 ft) integral sensor cable:	9.0m (30 feet)	12m (40 feet)	18m (60 feet)	<b>30.0m (100 feet)</b>
<b>With 12m (40 ft) integral sensor cable:</b>	<b>15m (50 feet)</b>	<b>18m (60 feet)</b>	<b>24m (80 feet)</b>	<b>36.0m (120 feet)</b>

**Approach # 3:** Sensors with integral cable and female snap to tinned leads cable extension to terminal strip:

	<b>+1.5 meters</b>	<b>+3 meters</b>	<b>+6 meters</b>	<b>+12 meters</b>
With 1.5m (5ft) integral sensor cable:	3m (10 feet)	4.5m (15 feet)	7.5m (15 feet)	<b>13.5m (45 feet)</b>
With 3m (10 ft) integral sensor cable:	4.5m (15 feet)	6m (20 feet)	9m (30 feet)	<b>15m (50 feet)</b>
With 6m (20 ft) integral sensor cable:	7.5m (15 feet)	9m (30 feet)	12m (40 feet)	<b>18m (60 feet)</b>
<b>With 12m (40 ft) integral sensor cable:</b>	<b>9m (30 feet)</b>	<b>12m (40 feet)</b>	<b>18m (60 feet)</b>	<b>24m (80 feet)</b>

Standard installations requiring cable lengths longer than 18 meters (60 feet) or **special order style installations requiring cable lengths longer than 36 meters (120 feet)** are achieved by using multiple female snap to male snap cable extensions. This can increase the total cable length in increments of 3m (10 feet), 6m (20 feet) & 12m (40 feet) or **24m (80 feet) with special order snap to snap cable extensions**. The snap to snap & snap to tinned leads cable extensions can be used together in any combination without signal degradation provided the **maximum supported 610 meters (2,000 feet) total cable length is not exceeded**.

**Items denoted in GREEN are special orders. This means that there may be limited availability and/or extended lead times for purchase of these items or to invoke these options. Contact ASTI factory or distributor for further details.**

## ALTERNATE FIELD INSTALLATION SCHEMES - PART 3

Detail drawing for standard smart digital HiQ sensor male snap connector cable termination (-HiQ-Xm):

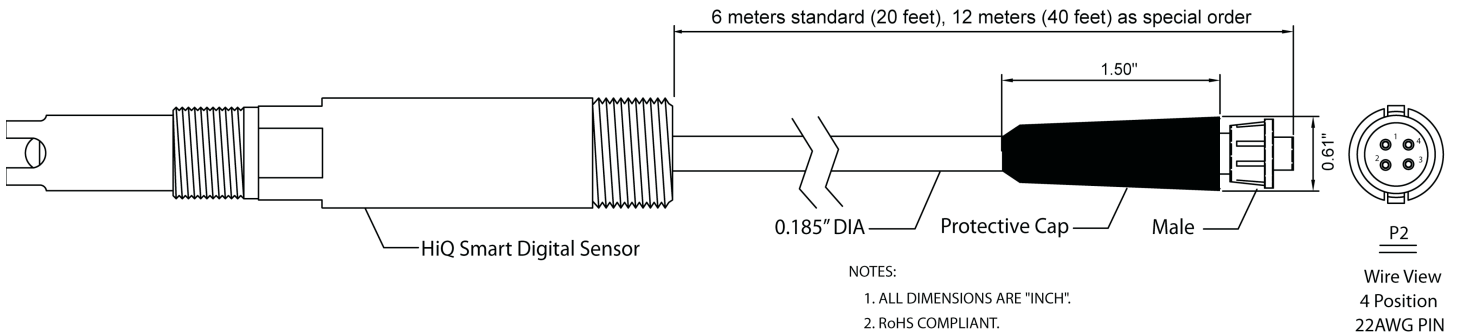

Detail drawing for female snap to male snap HiQ4F-Xm-HiQ4M cable extensions:

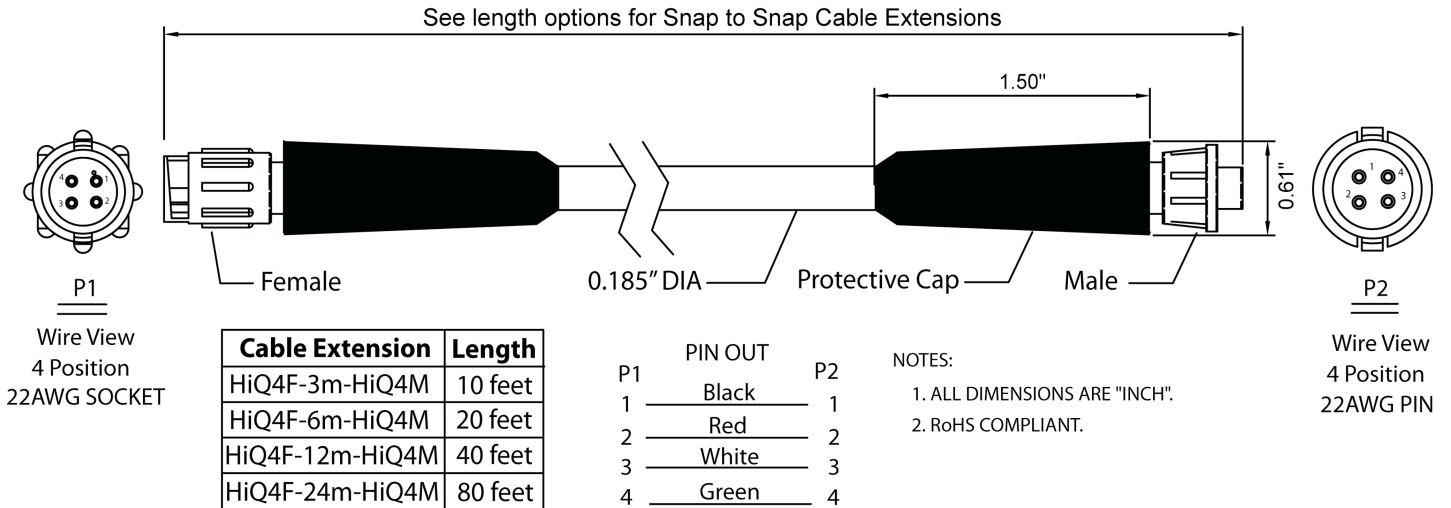

Detail drawing for female snap to tinned leads HiQ4F-Xm-TL cable extensions:

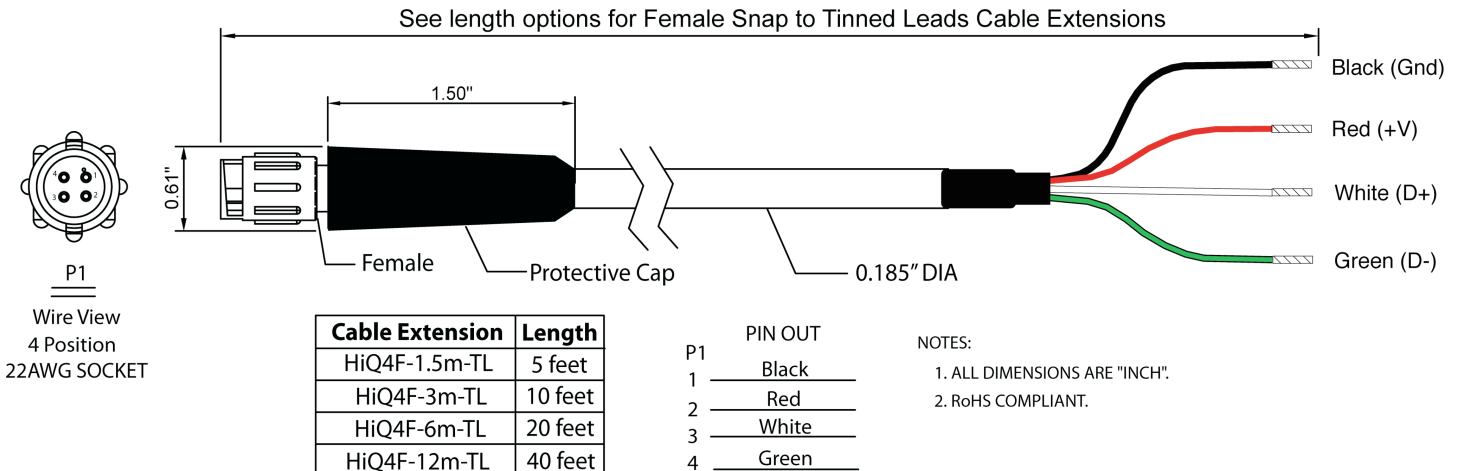

## ALTERNATE FIELD INSTALLATION SCHEMES - PART 4

The terminal assignments for red, black, white & green colored leads are detailed on page 1 of this installation guide. Care should be taken when making these connections to follow the terminal assignments exactly to avoid damaging the HiQ sensor or transmitter. No connection of any kind should be made to the factory-reserved input terminal 3.

### Assembly Drawing for Alternate Installation Approach # 1:

Smart digital HiQ sensor with male snap connector is interfaced directly to female panel mount snap connector on bridge box assembly. This approach requires the max distance between sensor & bridge box is no more than 6 meters (20 feet) for the standard digital HiQ sensors or 12 meters (40 feet) for the special order long cable version.

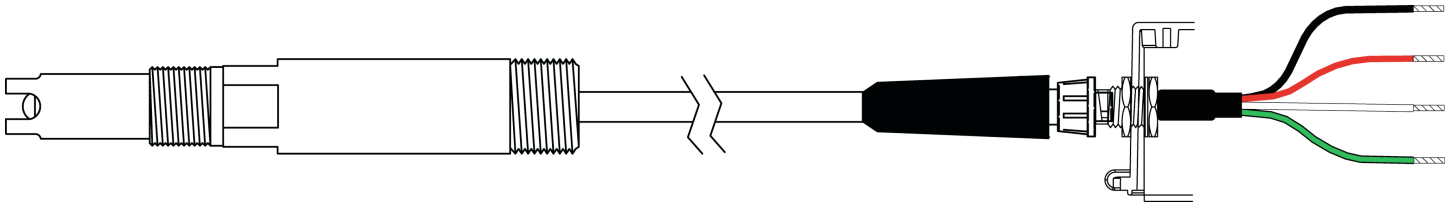

### Assembly Drawing for Alternate Installation Approach # 2:

Smart digital HiQ sensor terminated with male snap connector is bridged with snap to snap (HiQ4F-Xm-HiQ4M) cable extension which is interfaced to female panel mount snap connector that has been installed into bridge box assembly. Multiple snap-to-snap extension cables can be employed as desired at time of commissioning or any time thereafter.

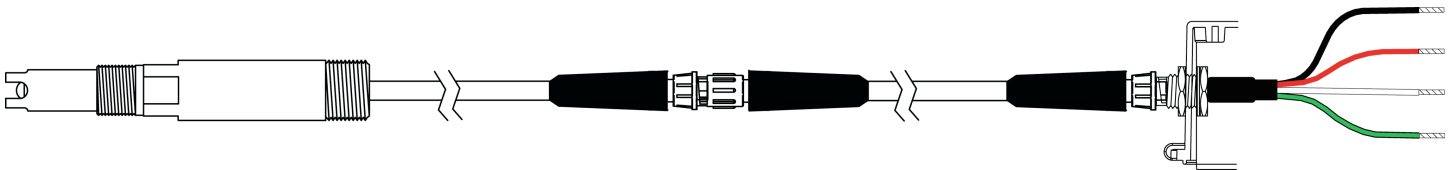

### Assembly Drawing for Alternate Installation Approach # 3:

Smart digital HiQ sensor terminated with male snap connector is bridged with snap to tinned leads (HiQ4F-Xm-TL) cable extension. The tinned leads are interfaced to 3TX-HiQ terminals & sealing cable gland is installed on bridge box assembly to secure the cable. This approach allows for user supplied bridge boxes to bridge the tinned lead terminations.

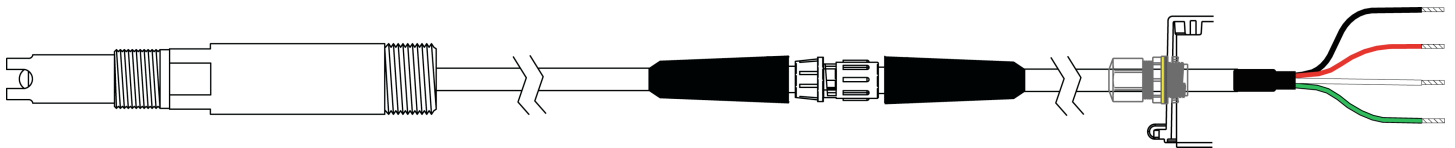

### Assembly Drawing for Alternate Installation Approach # 3 (Special)

Smart digital HiQ sensor terminated with male snap connector is bridged with both snap to snap (HiQ4F-Xm-HiQ4M) cable extension and snap to tinned leads (HiQ4F-Xm-TL) cable extensions. Tinned leads ultimately interfaced to 3TX-HiQ terminals and sealing cable gland is installed on bridge box or transmitter enclosure assembly (page 1 has wiring details).

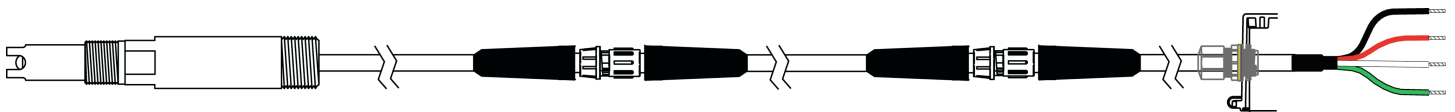

**ALTERNATE FIELD INSTALLATION SCHEME PHOTOS – PART 1 OF 2**  
**HiQ4FP PANEL MOUNT SNAP CONNECTORS FOR SMART DIGITAL HIQ SENSORS TO TINNED LEADS BRIDGE BOX ASSEMBLIES (APPROACH # 1 & 2)**

1MF-HiQ4FP-TERM4-CG (Item # 14108) Single Input Bridge Box for IOTRON™ Smart Digital Sensors  
1 each HiQ4FP female panel mount snap connector interfaces HiQ4M male snap connector from sensor or cable extension  
1 each four (4) pole terminal strip to connect extension cable with tinned lead terminations  
1 each ½" MNPT cable gland seal mating tinned lead to tinned lead extension cable that interfaces 3TX-HiQ transmitter



Smart Digital Sensor Connection View with Sealing Cap Off

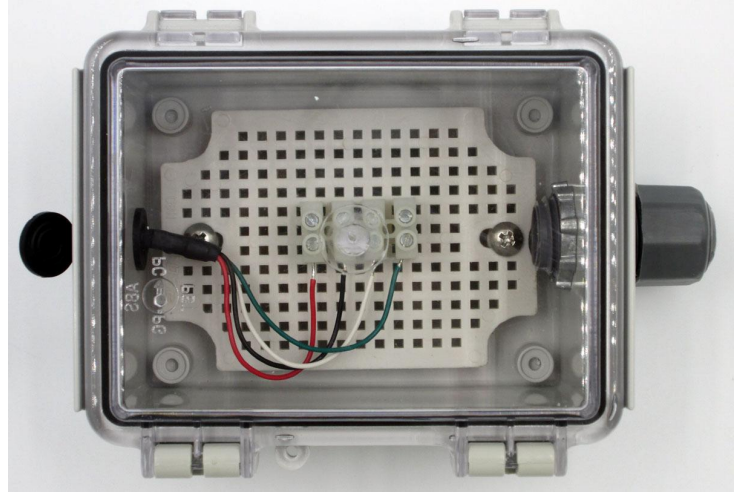

Lid Closed Top View for NEMA 4X rated connection when interfaced

1MF-2EA-TERM4-2EA-HiQ4FP-SCG (Item # 14109) Dual Input Bridge Box for IOTRON™ Smart Digital Sensors  
2 each HiQ4FP female panel mount snap connector interfaces HiQ4M male snap connector from sensor or cable extension  
2 each four (4) pole terminal strip to connect extension cable with tinned lead terminations  
2 each ¼" MNPT small cable gland seal mating tinned lead to tinned lead extension cable that interfaces 3TX-HiQ transmitter



Two (2) each Smart Digital Sensor Input Connection View with sealing caps off ready to interface HiQ4M male snap connector inputs

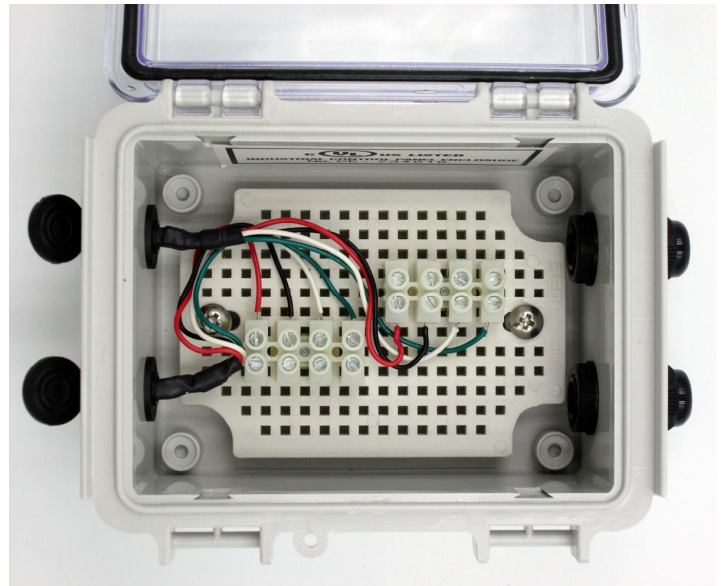

Lid open top view for 2 ea four (4) pole terminal strips to accept 2 ea extension cable with ¼" MNPT sealing cable glands shown on right

## ALTERNATE FIELD INSTALLATION SCHEME PHOTOS – PART 2 OF 2 TINNED LEADS TO TINNED LEADS BRIDGE BOX ASSEMBLIES FOR APPROACH #3 TYPE INSTALLATIONS

1MF-CG-TERM8-CG (Item # 14109) Single Input Bridge Box for extending tinned lead terminations  
 1 each eight (8) pole terminal strip to connect extension cable with tinned lead terminations  
 2 each ½" MNPT cable gland seal mating tinned lead to tinned lead extension cable that interfaces 3TX-HiQ transmitter



One (1) each Sensor Input & One (1) each Sensor Output  
 Side view with sealing caps & mounting kit installed below



Detail view of ½" MNPT cable gland used for securing sensor input and output cables isometric view

1MF-2EA-SCG-2EA-TERM4-2EA-SCG Dual Input Bridge Box Assembly for extending tinned leads (NOT SHOWN)  
 2 each four (4) pole terminals to connect tinned leads style extension cables to HiQ4F-Xm-TL female snap to tinned leads extensions  
 4 each ¼" MNPT small cable glands seal mating tinned lead to tinned lead extension cable that interfaces 3TX-HiQ transmitter

### DETAIL CLOSE-UPS OF HIQ4FP PANEL MOUNT & WALL/PLATE MOUNTING



HiQ4FP Female Panel Mount Connector keyed to interface only HiQ4M male snap connector from smart digital HiQ sensors with Four (4) each rugged 22AWG male pins for secure interface



Standard Wall/Plate mounting hardware for 1MF enclosure. Above is the unassembled hardware & below is installed into bottom of 1MF enclosure



---

---

## 3TX-HiQ Digital Measurement System Troubleshooting Guide & FAQ

### **!!! WARNING !!!**

**The 3TX-HiQ digital transmitters are ONLY for use with genuine ASTI supplied IOTRON™ smart digital HiQ sensors. Connecting any other sensor (analog or digital) may permanently damage the 3TX-HiQ transmitter and/or improper sensor. If there should be any doubt as to whether you are connecting a genuine ASTI supplied IOTRON™ HiQ digital sensor to the 3TX-HiQ digital transmitter, please inquire to the ASTI factory for verification.**

The smart digital HiQ sensors are designed for a seamless and simple plug and play type operation with the intelligent digital 3TX-HiQ transmitters. In the case that any exception occurs a variety of diagnostic information may be displayed in the form of error codes reported on the 3TX-HiQ LED display. Instructions about what should be done if any of these error codes or diagnostic messages are displayed is provided below to assist with troubleshooting initial commissioning as well as ongoing maintenance of your installation.

The troubleshooting steps below are meant for use together with the specific 3TX-HiQ transmitter documentation in question as well as the general shared 3TX FAQ documentation rather than just as a standalone guide. Error codes are shown flashing on the display in the format "X.Y" where "X" is from 1 to 10 and "Y" can vary from 0 to 9. The exact coding designations are generally only relevant for internal uses by the ASTI factory. In particular the "Y" portion of the error code can be safely ignored unless specifically requested for remote diagnostic troubleshooting assistance purposes.

### **NO SENSOR CONNECTED OR IMPROPER WIRING ERRORS**

If no genuine IOTRON™ smart digital HiQ digital sensor is connected, it is expected that one or more error will be reported including the 2.Y type error code. If there is an HiQ digital sensor connected but it is not interfaced to the correct type of mating HiQ transmitter you will get a 3.Y measurement type mismatch error. It is very important to make sure that the four leads from the smart digital HiQ sensor are properly wired to the terminals on the 3TX-HiQ transmitter to prevent damage to the electronics. Please see page one (1) for the color coding and terminal designations of the four leads. Since the HiQ digital measurement system employs a NEMA 6P rated quick disconnect termination, the tinned lead connections need only be made correctly once to the HiQ transmitter.

### **COMMUNICATION ERRORS**

If an HiQ digital sensor is properly connected and an error code of the type 1.Y, 4.Y, 5.Y, 6.Y, 9.Y or 10.Y is received then these indicate that some form of a communication exception has occurred. Such errors are quite rare. If observed at all they are typically quite brief in duration signifying a very brief transient temporary communication issue. If these error codes starting with 1, 4, 5, 6 or 9 persist this indicates that there was some damage to the electronics inside the HiQ digital sensor and it must be replaced. Typically some ground loop or electrical/installation issue is responsible for this damage.

### **DATE STAMPING ERRORS**

If an error code of the type 7.Y or 8.Y is received then these indicate that some form of an error has occurred related to setting the field activation or the last date of field use. These errors are also extraordinarily rare and indicate either an improper configuration or else a corruption to that portion of the EEPROM (very unlikely). If the issue is simply an improper configuration this can be resolved at the ASTI factory. The sensor item number, serial number, invoice number and dispatch date will be requested for approval of any such return. All of this information can be obtained from the HiQ transmitter to which the digital sensor is connected by looking at the appropriate parameters (see transmitter manual).

### **GENERAL TROUBLESHOOTING TIPS**

- Ensure that all snap connections with the extension cables are secure and that none of the pins are damaged.
- Ensure that there is good integrity of PVC insulation on leads & cable jacket for both sensor and/or extension cables.
- Disconnect and reconnect the digital sensor via the snap connection. Allow ~5 to 10 seconds before reconnecting.
- Cycle the power to the transmitter and swap out the extension cable for a unit that is known to be working.
- Connect a genuine HiQ digital sensor known to be working to ensure 3TX-HiQ transmitter is functioning normally.

*Last Modified June 3, 2016 | Revision 8*



THIS PAGE HAS BEEN INTENTIONALLY LEFT BLANK